

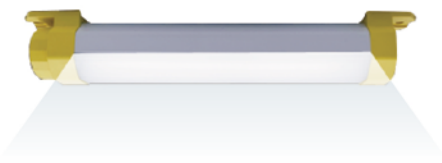

CABINET LIGHTING



PL263



- Ear mounting
- Double strong magnetic system
- Lithium battery
- Multi light mode
- Function of power bank

PL233/400



- Ear mounting
- Multi light mode
- Double strong magnetic system
- Function of power bank
- Lithium battery



SPECIFICATION

Model	PL263
Dimensions	263x43.6x41mm
Voltage	DC5V
Power	5W
Electric current	1A
Weight	0.2kg
Screw installation	250mm
Light quantity	500LM
Color temperature	6000K
The use of bearing	-20°C~+40°C
Installation mode	Magnet tightening/screw installation
Working life	50000h
Switch type	Button Switch
Switch mode	Seven modes: Main light (10%/50%/100%) and flashlight (50%/100%/SOS/Strobe)
Certificate	CE. EMC. ROHS

SPECIFICATION

Model	PL233	PL400
Dimensions	272*38*21mm	448*38*21mm
Voltage	USB 5V	USB 5V
Power	6W	10W
Charging time	3.5h	4h
Weight	0.22kg	0.28kg
Screw installation	250mm	425mm
Light quantity	>650LM	
Color temperature	5000~6500K	
The use of bearing	-10°C~+45°C	
Induction distance	2m(The human body automatically shuts off after 20 seconds of leaving)	
Installation mode	Magnet tightening/screw installation	
Working life	50000h	
Control mode	Constant light mode/human body sensing mode	
Certificate	CE. EMC. ROHS	

DIMENSION (mm)

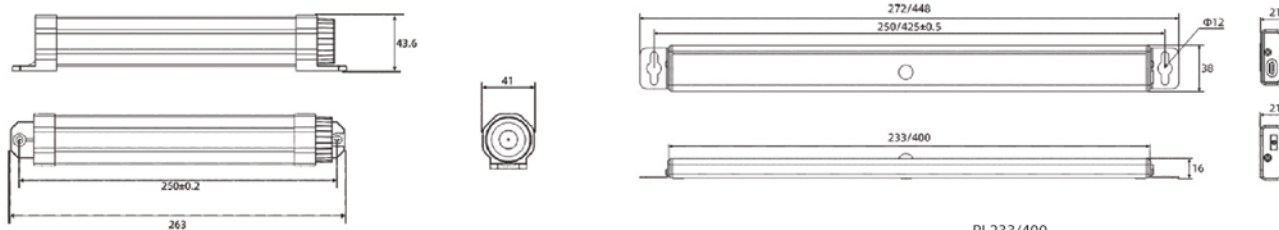

PL233/400



Installation accessories

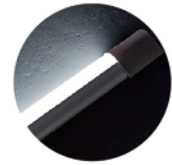

Switch & Cable



Part # Definition

LCL - 6W. 230. M - C (G)

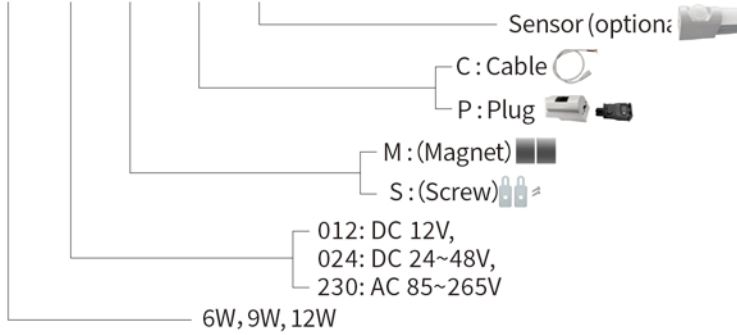

SPECIFICATION

Model	LCL-6W.230	LCL-9W.230	LCL-12W.230
	LCL-6W.024	LCL-9W.024	LCL-12W.024
Material	Aluminum+PC		
Power	6W	9W	12W
Voltage	230(AC85~265V) / 024(DC12~48V)		
Luminous flux	640LM	910LM	1440LM
Mounting	Screw or Magnet		
Power connection	Cable or Plug		
Color temperature	6500K		
Rendering index	Ra > 75%		
Operation temperature	-20°C ~ +60°C		
Additional feature	Sensor Optional		
IP code	IP20		

DIMENSION (mm)

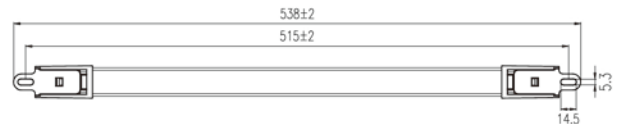
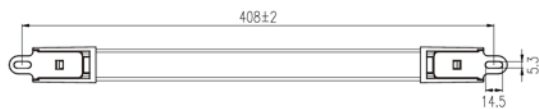
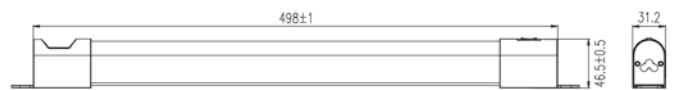
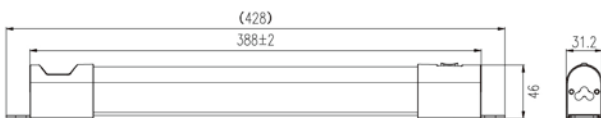

LCL-6W/9W

LCL-12W

Installation accessories



IP20 CE -20 +60

SPECIFICATION

Model	LK026-AC.M (Magnet Mounting)	LK026-DC.M (Magnet Mounting)
	LK026-AC.S (Screw Mounting)	LK026-DC.S (Screw Mounting)
Power	6W	
Voltage	AC 85~265V	DC 12~72V
Luminous flux	690LM	
Power connection	Push-in terminal	
Color temperature	6500K	
Rendering index	Ra>72%	
Operation temperature	-40°C~60°C	
Additional feature	Sensor Optional	
IP code	IP20	

DIMENSION (mm)

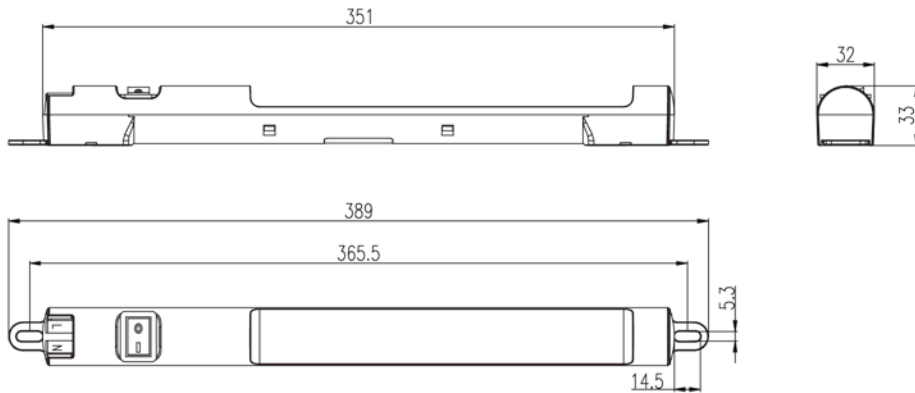



PL315.220

PL365.220

PL415.220

PL442.220

PL442S.220

PL442S-SCREW FIX

IP20 **CE**

SPECIFICATION

Model	PL315.220	PL365.220	PL415.220	PL442.220	PL442S.220	PL442S-SCREW FIX
Dimensions	315x24x55mm	365x24x55mm	415x24x55mm	442.4x79x26.4mm	444x80x50mm	449x77x50mm
Power	4W	6W	8W	12W	8W	8W
Input voltage	96~265V	96~265V	96~265V	220V~240V	220V~240V	220V~240V
Frequency	50/60Hz	50/60Hz	50/60Hz	50/60Hz	50/60Hz	50/60Hz
LED luminous	320LM	480LM	640LM	1100LM	800LM	1000LM
Color temperature	6500K	6500K	6500K	6500±200K	6500±200K	6500±200K
Induction time	30 S	30 S	30 S	30 S	30 S	30 S
Sensor distance	3 meters	3 meters	3 meters	3 meters	3 meters	3 meters
IP code	IP20	IP20	IP20	IP20	IP20	IP20

DIMENSION (mm)

PL315.220/PL365.220/PL415.220

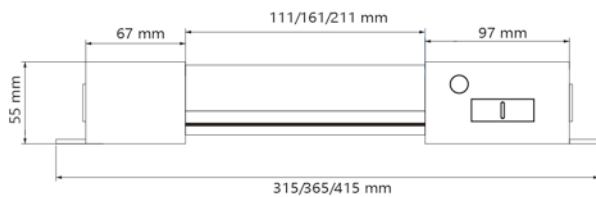

PL442.220

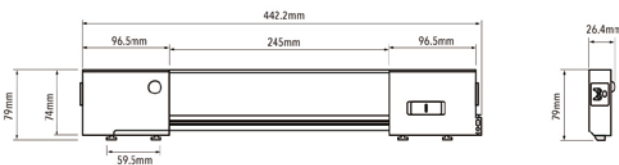

PL442S.220

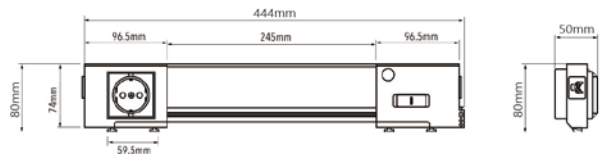

PL442S-SCREW FIX

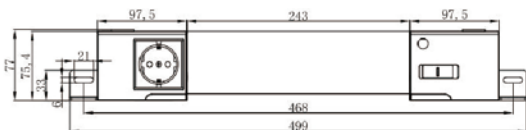

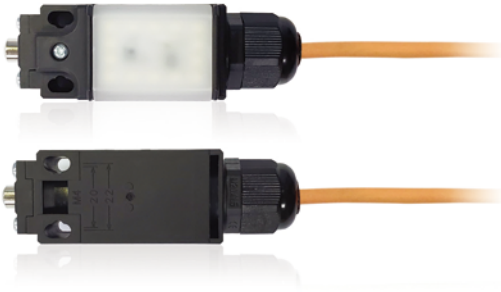

PCLS LED40



PCLS LED40(131)



SPECIFICATION

Model No.	PCLS LED40	PCLS LED40(131)
Rated voltage	AC 180-230V	
Rated power	1.5W	
Luminous flux	>600LM	>200LM
Color temperature	6000-6500K	
Mean life	20,000h	
Operating temperature range	-10°C~+70°C	
Switch mode	Stroke (gated) switch	
Mounting	Screw fixing	
Cable length	2000mm	
IP code	IP20	

Connection Example

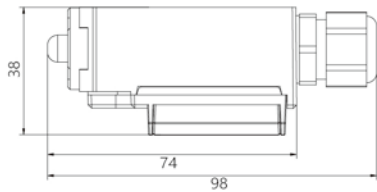

PCLS LED40

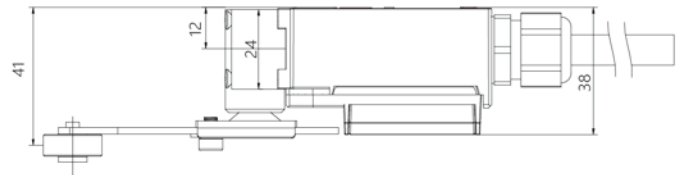

PCLS LED40(131)

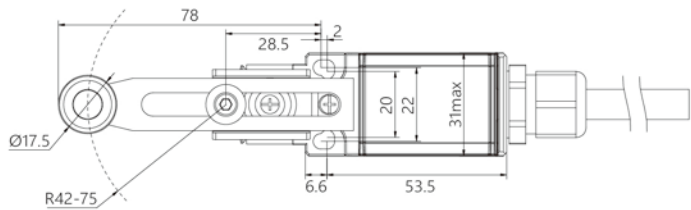
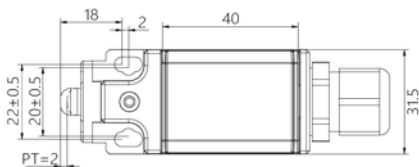

Application

LK12-W Series LED light is designed for instrument cabinet illumination of various switchgear, built in infrared sensor switch, and simplify the user's application design.

Features and advantage

- Built in infrared sensor switch, the user do not install additional switch.
- Economize on energy, In the case of illuminate effect same alike the traditional light, economizing on energy is 75% above.
- Life span is long, the LED light source, someone call it the longevity light, meaning to extinguish never. It's the solid cold light source, adopt a special electric circuit design, the life span can reach to for 100,000 hours, comparing traditional light source life span to grow 1000% above.
- The environmental protection performance is better, without ultraviolet ray and infrared rays in the spectrum, without calories and radiate, the dizzy light is small, and the castoff can recover, without pollution and do not contain the mercury chemical Element. The cold light source, can be touched, belong to typical model of the green illuminate light source.
- Special circuit design, if anyone LED is bad, it isn't without influence to normal illumination of others LED.
- Special structure design, light body position can be adjusted, that solves the problem of less illumination angle of LED.



Model Explanation

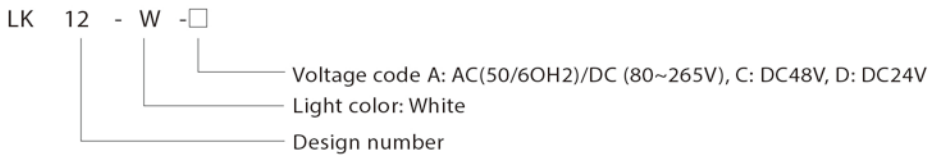

SPECIFICATION

Model	LK-12W(sensor)	LK-13W
Power supply	AC(50/60hz)/DC (80~265v), or other voltage customer demand.	
Average illuminance at 300mm from lamp	>3001x	
Color rendering index Ra	> 85	
Switch	Built in infrared switch, active distance 20~80mm	Built in switch
Terminal	Screw terminal, 0.5~2.5mm ²	
Working environment temperature	-25°C~55°C	
Fix method	Two hole fixation	
Color of the light	White	
IP code	IP20	
Withstand voltage	AC2500V, 1 min	
luminescence component	LED	
Rated humidity	25~95%	
Mean life	More than 100,000h	
Power	6W	

DIMENSION (mm)

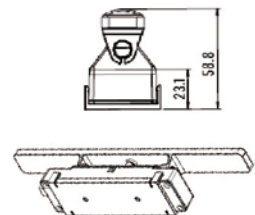
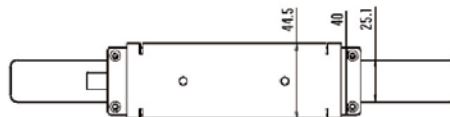
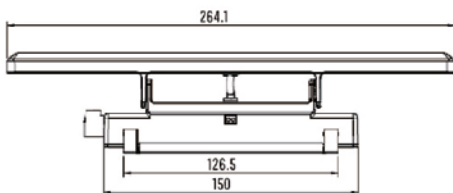

LKL10 series

CABINET LIGHTING

LKL10-W series cabinet instrument room lighting is designed for all kinds of switchgear instrument room lighting applications.

Features and advantage

- Economize on energy, In the case of illuminate effect same alike the traditional light, economizing on energy is 75% above.
- Life span is long, the LED light source, someone call it the longevity light, meaning to extinguish never. It's the solid cold light source, adopt a special electric circuit design, the life span can reach to for 100,000 hours, comparing traditional light source life span to grow 1000% above.
- The environmental protection performance is better, without ultraviolet ray and infrared rays in the spectrum, without calories and radiate, the dizzy light is small, and the castoff can recover, without pollution and do not contain the mercury chemical Element. The cold light source, can be touched, belong to typical model of the green illuminate light source.
- Special circuit design, if anyone LED is bad, it isn't without influence to normal lamination of others LED.
- Special structure design, light body position can be adjusted, that solves the problem of less lamination angle of LED.
- The power supply adapt to AC/DC110~230V, suitable in application case of switchgear especially .

Install

It can be assembled by pins or screws. When assembling, fix the mounting bracket first. After connecting the power cord to the lamp body terminal, insert one end of the wiring terminal of the lamp body into the assembly hole on one side of the mounting bracket. At the other end, use a tool (using a straight screw batch) to open the other side of the mounting bracket and insert it.

The Angle between the mounting bracket and the lamp body can be adjusted according to lighting requirements.



LKL10-W



LKL10-W-3



Model number	LKL10-W	LKL10-W-3
Light source color	White	black
power	1.2 W	3W

SPECIFICATION

Housing material	Power supply	Wire connection	Insulation strength	Light-emitting element	Relative humidity	Life cycle	IP code
PC-ABS (Halogen free)	AC(50/60Hz) DC 110V~230V	1×4mm ² 2×1.5 mm ²	AC2500V, 1Min	LED	25~95%	More than 100000 hours	IP20



LKL10-W lamp body



LKL10-W support



LKL10-W assembly

DIMENSION (mm)

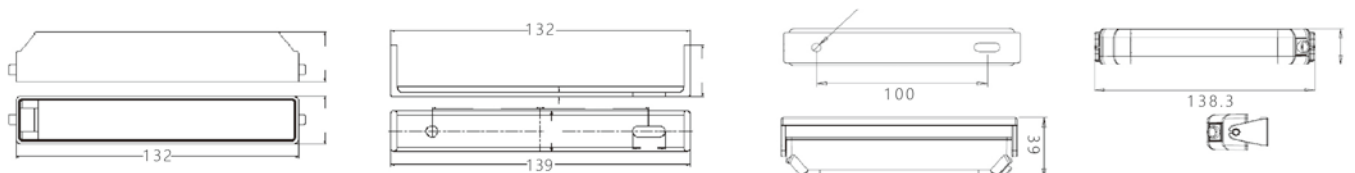

LKL10-W

LKL10-W-3

PLS-101



PLS-103



PLS-131



IP20 CE

Model	PLS	101	103	131
Operating force	OF[Max.]	700g	700g	500g-cm
Release force	RF[Min.]	200g	200g	100g-cm
Pre-Travel	PT[Max.]	1.8mm	1.8mm	20°
Tripping position	Tp±10%	2.0mm	2.0mm	22.5°
Movement differential	MD[Max.]	1.2mm	1.2mm	10°
After travel	OT[Min.]	4.0mm	4.0mm	75°
Total travel	TT[Min.]	5.8mm	5.8mm	95°
Angle of rotary lever	-	-	-	22.5°

DIMENSION (mm)

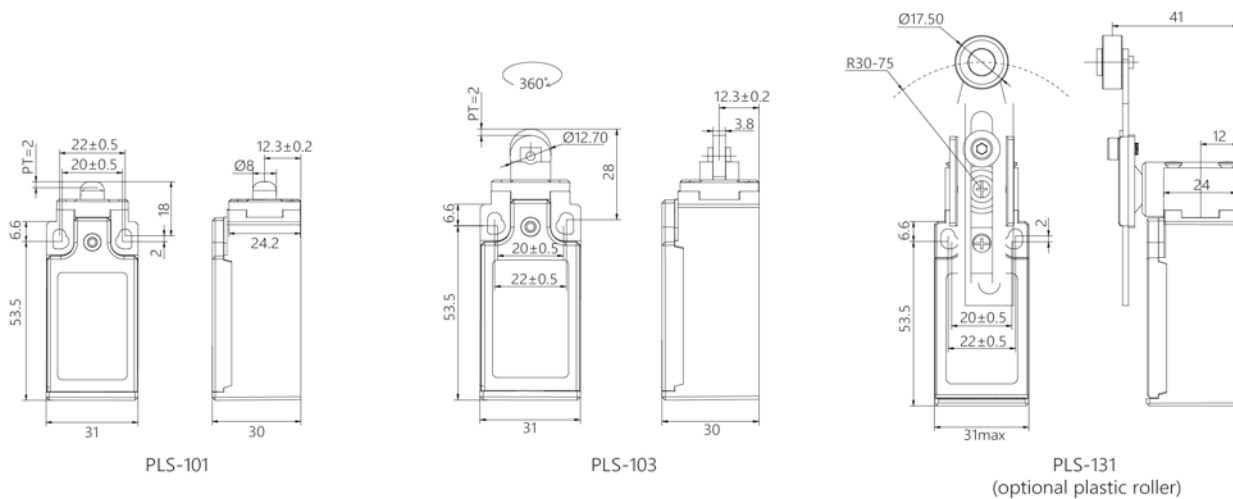



Features

- Economic thermoplastic
- Stainless steel roller, punch, and Spring
- Max. $\pm 95^\circ$ rotary lever
- Cable gland size M20*1.5

PLS-101 is a commonly used model, with wire models:

PLS-101-1 (With 1m cable)

PLS-101-2 (With 2m cable)

PLS-101-3 (With 3m cable)

Note: The above is the overall model of the door control switch with wires and mounting base. The default wire length is 2m.

Contact configurations

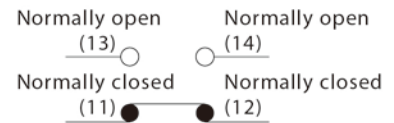

SPECIFICATION

Operating speed	0.5 mm/s~50cm/s (in case of pin plunger)
Operating frequency	Mechanical: 120 operations/ min Electronic: 30 operations/ min
Contact Resistance	25mΩ (mm) (Initial)
Insulation resistance	100mΩ Min. at 500VDC
Dielectric strength	1,000 VAC (50/60Hz, 1 min): Between terminals of the same polarity. 1,500 VAC (50/60Hz, 1 min): Between current-carrying parts and ground. Between each terminal and non-current-carrying metal parts.
Vibration resistance	10-55 Hz, 1.5mm double amplitude
Shock resistance	Mechanical durability: 1,000m/Sec ² (approx.100G`S) False action durability: 300m/Sec ² (approx.30G`S)
Ambient operating temperature	Operating -10°C~+ 70°C(no icing)
Ambient operating Humidity	95%RH Max
Service life	Mechanical > 10,000,000 operations, Electrical > 500,000 operations
IP code	IP65 (IEC standard)

RATINGS

Rated voltage	Non-inductive load (A)				Inductive load (A)			
	Resistive load		Lamp load		Inductive load		Motor load	
	NC	NO	NC	NO	NC	NO	NC	NO
125VAC	5	5	1.5	0.7	3	3	2	1
250VAC	5	5	1	0.5	3	3	1.5	0.8
8VDC	5	5	3	3	5	4	3	3
14VDC	5	5	3	3	4	4	3	3
30VDC	5	5	3	3	4	4	3	3
125VDC	0.4	0.4						
250VDC	0.2	0.2						
Inrush current	N.C.:24A max., N.O.:12A max.							

Note: 1. Inductive loads have a power factor of 0.4 min. (AC) and a time constant of 7 msec max. (DC).
2. Lamp loads have an inrush current of 10 times the steady-state current. Motor loads have an inrush current of 6 times the steady-state current.
3. For the products with spring, the operating range is limited to the part from the front of the spring to the 1/3 full length of the spring .



SPECIFICATION

Model	LKP3 1801
Dimensions	85x85x112.5mm
Voltage	PP plastic
Power	2-bit lock+1-bit automatic return
Air volume	10A
Noise	1NO+1NC
Weight	295g
Installation direction	3000000/time
Installation mode	vertical
The use of bearing	25°C~+70°C
IP code	IP65

WJ - 1

DIMENSION (mm)



WJ - 3

DIMENSION (mm)



WJ - 4

DIMENSION (mm)



Product back

Material:

Plastic ABS with self-adhesive fastening trips 3M adhesive tape

Installation:

Plastic Documents Pocket for affixing to the inside surfaces of panel doors, screw mounting or adhesive tape mounting

Color:

Similar to RAL7035



WJ-1(A4)